

KLUDI BINGO STAR XS

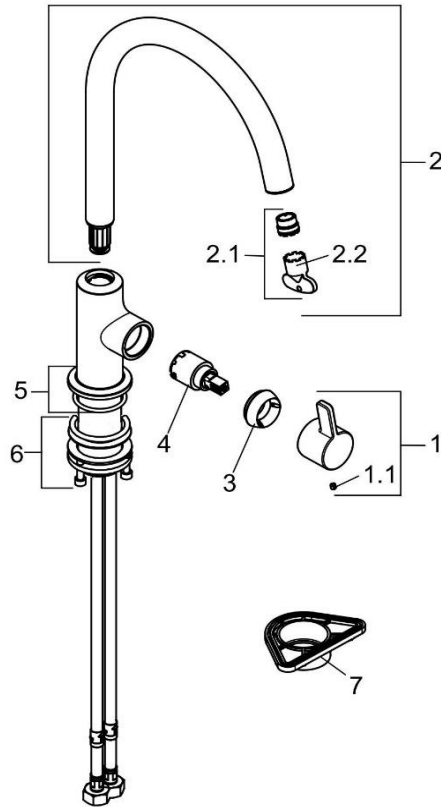

468033978		Spültisch-Einhandmischer DN 15	single lever sink mixer DN 15
1	7358339-00	HEBEL	LEVER
1.1	91726335-00	GEWINDESTIFT	GRUB SCREW
2	7363339-00	AUSLAUF	SPOUT
2.1	7301700-00	STRAHLREGLER	AERATOR
2.2	93069300-00	STRAHLREGLERSCHLÜSSEL	WRENCH FOR AERATOR
3	92217039-00	SPANNSCHRAUBE	FASTENING SCREW
4	7486800-00	STEUEREINHEIT	CERAMIC CARTRIDGE
5	7319739-00	ROSETTE	ESCUTCHEON
6	7883000-00	BEFESTIGUNGSSATZ	MOUNTING KIT
7	93001600-00	VERSTÄRKUNGSPLATTE	STABILIZER PLATE