

Product: KLUDI MEDI CARE wall mounted single lever mixer DN 15

Ref.: 349210524

Product description

wall mounted single lever mixer DN 15
 arm lever for hospital purpose
 wall fastening
 flow class Z
 flow rate 8 l/min
 care jet-spray regulator M 24 x I
 safety ceramic cartridges with hot water safety stop
 movable and lockable spout
 projection 250 mm
 lockable S-unions
 noise group II
 PA-IX 9574/IIZ

Finishes:
 05 chrome

Product picture



Advertisement

- * KLUDI GmbH & Co. KG KLUDI MEDI-CARE single lever wall mixer item no. 349210524
- ** safety ceramic cartridge with hot water safety stop Ø 35 mm, DIN EN 817
- *** chrome plated brass, DIN 50930-6

single lever wall mixer DN 15, manufacturer KLUDI GmbH & Co. KG KLUDI MEDI-CARE single lever wall mixer item no. 349210524, DN 15, chrome plated brass, safety ceramic cartridge with hot water safety stop Ø 35 mm, flow rate 8 l/min, type: single lever wall mixer DN 15, movable and lockable spout, PCA care- non aerated M 24 x I, noise level DIN EN 4109 group II, report no. PA- IX 9574 / IIZ, lever projection 160 mm, lockable S unions 1/2 x 3/4 inch, nozzle projection 250 mm, overall length 209 mm, arm lever for hospital purpose, for pressure type water heater, for continuous line heater, PN 10,

Dimensional drawing

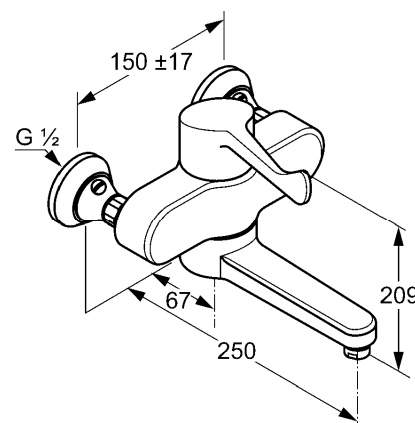

Flow rate diagram

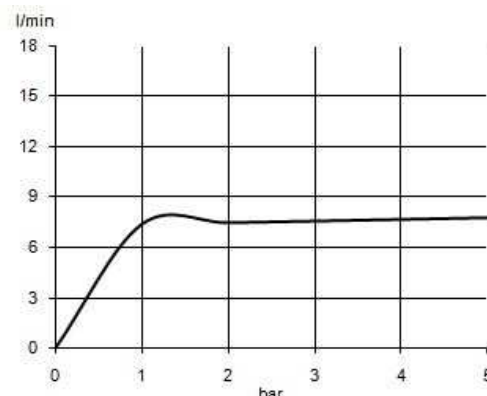

Laminarstrahl
 non aerated