

Product: KLUDI PROVITA wall mounted single lever mixer DN 15

Ref.: 335320500

Product description

wall mounted single lever mixer DN 15
 choice of lever: HOSPITAL or PUBLIC
 wall fastening
 flow class Z
 flow rate 7,6 l/min
 PCA care jet-spray regulator M 24 x I
 ceramic cartridge with hot water safety device
 movable or lockable spout
 S-unions
 noise level I, PA- IX 19337/IZ
 without HOSPITAL – lever ref. 7491005-00
 without PUBLIC - lever ref. 7493005-00

Oberfläche:
 05 chrom



Advertisement

- * KLUDI GmbH & Co KG KLUDI PROVITA wall mounted single lever mixer item no. 335320500
- ** ceramic cartridge with hot water safety device Ø 41 mm, DIN EN 817
- *** chrome plated brass, DIN 50930-6

wall mounted single lever mixer DN 15, manufacturer KLUDI GmbH & Co KG KLUDI PROVITA wall mounted single lever mixer item no. 335320500, DN 15, chrome plated brass, ceramic cartridge with hot water safety device Ø 41 mm, flow rate 7,6 l/min, type: wall mounted single lever mixer DN 15, movable or lockable spout, PCA care-non aerated M 24 x I, noise level DIN 4109 group I, report no. PA- IX 19337/IZ, lever projection 120/180 mm, S unions 1/2 x 3/4 inch, nozzle projection 180/247 mm, choice of lever: HOSPITAL lever ref. 7491005-00 (180 mm) or PUBLIC lever ref. 7493005-00 (120 mm), for pressure type water heater, for continuous line heater, PN 10,

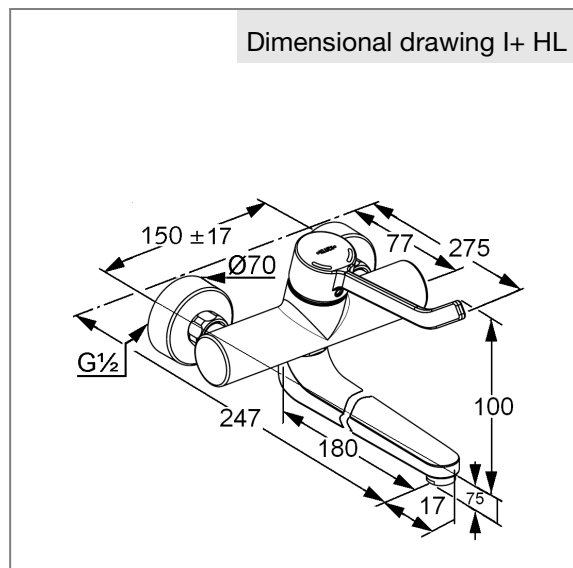

Flow rate diagram

