

Product: KLUDI ZENTA concealed 2-hole basin mixer, trim set

Ref.: 382440575

Product description

concealed 2-hole basin mixer
trim set
solid lever
flow class Z
s-pointer eco aerator M 24 x l
Ø disc 70 mm
projection 180 mm
without pre-installation set 38243

Finishes:
05 chrome

Product picture



Advertisement

- * KLUDI GmbH & Co KG KLUDI ZENTA concealed 2-hole basin mixer - trim set item no. 382440575
- ** brass, DIN 50930-6, DIN EN 817

concealed 2-hole basin mixer - trim set, manufacturer KLUDI GmbH & Co KG KLUDI ZENTA concealed 2-hole basin mixer - trim set item no. 382440575, chrome plated brass, solid lever, noise level DIN 4109 group I, without report no., type: concealed 2-hole basin mixer trim set DN 15, flow class Z (max. 0,15 l/s), s-pointer eco aerator M 24 x l, nozzle projection 180/190 mm, lever projection 77 mm, without concealed pre-installation set DN 15 item no. 38243, covering Ø disc 70 mm, for pressure type water heater, continuous line heater, PN 10,

Dimensional drawing

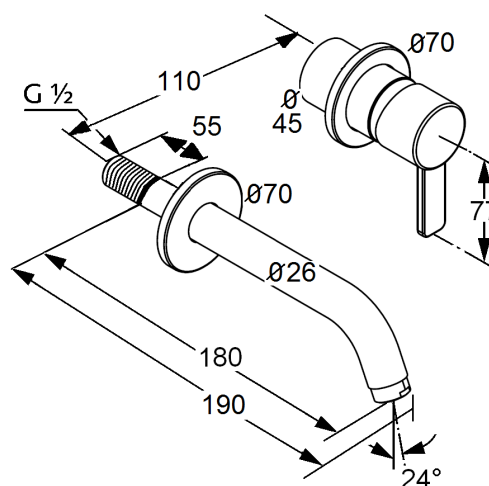

Flow rate diagram

