

Product: KLUDI MX multi single lever sink mixer DN 15

Ref.: 39945..62

Product description

multi single lever sink mixer DN 15
 single hole mounted
 open ring lever
 ceramic cartridge with hot water safety device
 cascade aerator M 24 x 1
 flow class A
 swivel spout (110°), pull-out hand shower
 automatic diverter: jet/spray
 one connection for washing-machine or dishwasher
 protected against backflow
 copper tubes Ø 10 mm
 shank-fixing
 noise group I, PA-IX 18642/IA0

Finishes:
 05 chrome
 82 chrome/mocca
 91 chrome/white

Advertisement

multi single lever sink mixer, manufacturer KLUDI GmbH & Co KG
 KLUDI MX item no. 39945..62
 type: sink multi single lever mixer DN 15 / PN 10 with swivel (range 110°) and pull out hand sry, made of brass, finishes selectable: 05 = chrome; 82 = chrome/mocca; 91 = chrome/white, open ring lever made of metal, ceramic cartridge K-41 with hot water safety device, cascade aerator M 24 x 1, flow rate 8,5 l/min at 3 bar, with separate connection for washing machine or dishwasher 3/4 inch, with copper tubes Ø 10 mm length 350 mm, with shower hose M 15 x 1 x 1500 mm and counterweight with W270 / KTW approval, plastic hand spray with automatic diverter, protected against backflow DIN EN 1717, shank fixing, noise level DIN EN 4109 group I, report no. PA-IX 18642/IA0
 dimensions: height: 220 mm, nozzle height: 153 mm, projection: 225 mm, lever projection: 108 mm

Product picture



Dimensional drawing

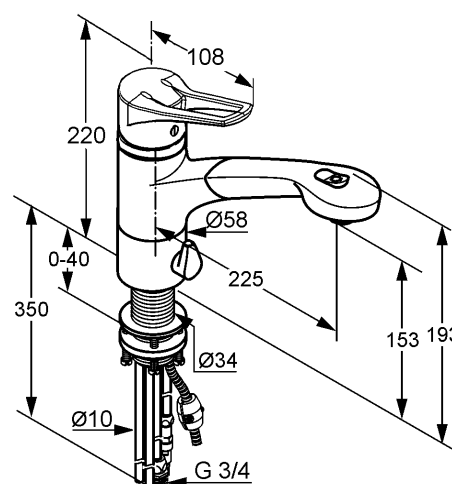

Flow rate diagram

