

**Product:** KLUDI PROVITA wall mounted single lever mixer DN 15

**Ref.:** 335330500

**Product description**

wall mounted single lever mixer DN 15  
 choice of lever: HOSPITAL or PUBLIC  
 wall fastening  
 flow class Z  
 flow rate 7,6 l/min  
 PCA care jet-spray regulator M 24 x I  
 ceramic cartridge with hot water safety device  
 movable or lockable spout  
 lockable S-unions  
 noise level I, PA- IX 19336/IZ  
 without HOSPITAL – lever ref. 7491005-00  
 without PUBLIC - lever ref. 7493005-00

Oberfläche:  
 05 chrom

Product picture



**Advertisement**

- \* KLUDI GmbH & Co KG KLUDI PROVITA wall mounted single lever mixer item no. 335330500
- \*\* ceramic cartridge with hot water safety device Ø 41 mm, DIN EN 817
- \*\*\* chrome plated brass, DIN 50930-6

wall mounted single lever mixer DN 15, manufacturer KLUDI GmbH & Co KG KLUDI PROVITA wall mounted single lever mixer item no. 335330500, DN 15, chrome plated brass, ceramic cartridge with hot water safety device Ø 41 mm, flow rate 7,6 l/min, type: wall mounted single lever mixer DN 15, movable or lockable spout, PCA care-non aerated M 24 x I, noise level DIN 4109 group I, report no. P- IX 19336/IZ, lever projection 120/180 mm, lockable S unions 1/2 x 3/4 inch, nozzle projection 180/255 mm, choice of lever: HOSPITAL lever ref. 7491005-00 (180 mm) or PUBLIC lever ref. 7493005-00 (120 mm), for pressure type water heater, for continuous line heater, PN 10,

Dimensional drawing I+ HL

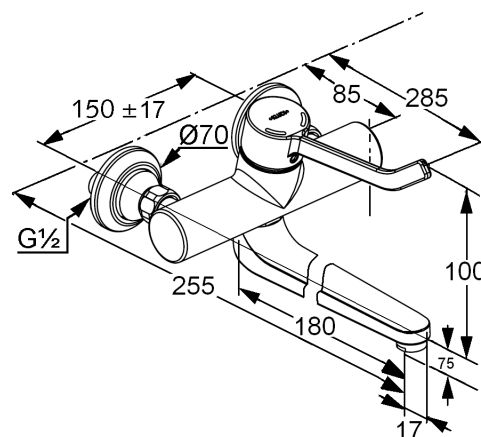

Dimensional drawing II + PL

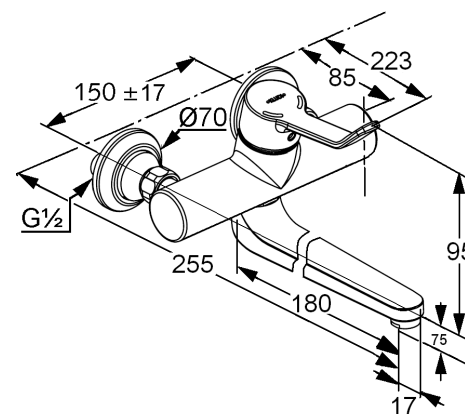

**Flow rate diagram**

